



LSX Series

High Performance Switch Mode AC Power Sources
Single, Split and Three Phase Mode
Pulse Width Modulation Amplifier Technology

Extensive Features:

- PWM Switch Mode Power Conversion Technology
- Three Phase, Split Phase and Single Phase Output Modes
- Frequency Range 15 - 1200Hz
- Phase Angle Programming on 3 ϕ Models
- Excellent Output Voltage and Load Regulation
- Metering of Volts, RMS Current, Peak Current, Apparent Power & True Power on all Phases
- Harmonic Measurements
- Scope Function to capture Voltage & Current waveforms
- Sine, Square, Triangle, Clipped Sine and Arbitrary Waveforms Selections
- Output LIST, PULSE and STEP Mode Transient Programming
- Standard USB, LAN, RS232 & GPIB Interfaces
- Compatible with Legacy UPC1/3 Controllers
- Available reduced feature set economy "M" version
- Built-in Web Servers for browser control
- Available instruments drivers for LabView™ and LabWindows™
- PPSC Manager Windows GUI Software

1500 VA to 6000 VA
Single, Split & Three Phase
Output Voltages up to 600VLL
15 - 1200 Hz



"Innovating Solutions for Control and Monitoring of Power"



OOO «4TECT»
Телефон: +7 (499) 685-4444
info@4test.ru
www.4test.ru

THE POWER OF EXPERTISE



FREQUENCY CONVERSION



AEROSPACE



R & D



MILITARY



MANUFACTURING



CUSTOM

Total Control, Metering and Analysis of AC Power.

Programming

PROGRAM				Apply All	
Freq.	400.00	Hz		Unlink Phases	
	Phase A	Phase B	Phase C		
Phase	0.00	120.0	240.0		Deg
Volt. AC	115.00	115.00	115.00	V _{RMS}	Protection
Curr. lim.	41.67	41.67	41.67	A _{RMS}	
Pow. lim.	4.60	4.60	4.60	kW	Peak Control
kVA lim.	5.00	5.00	5.00	kVA	
Ready Prog. MAN				LOC 3ph	Waveform

Metering

MEASUREMENTS 1 OF 2				Meas. Page 2	
Freq.	400.00	Hz		Fault Status	
	Phase A	Phase B	Phase C		
Volt. L-N	115.00	115.00	115.00		V _{RMS}
Current	25.67	25.67	25.67	A _{RMS}	Error and Event
Power	2.655	2.555	2.655	kW	
	V _{AB}	V _{BC}	V _{CA}		Real Time Plot
Volt. L-L	199.20	199.19	199.20	V _{RMS}	
Ready Prog. MAN				LOC 3ph	Individual Phase

Menu Keys

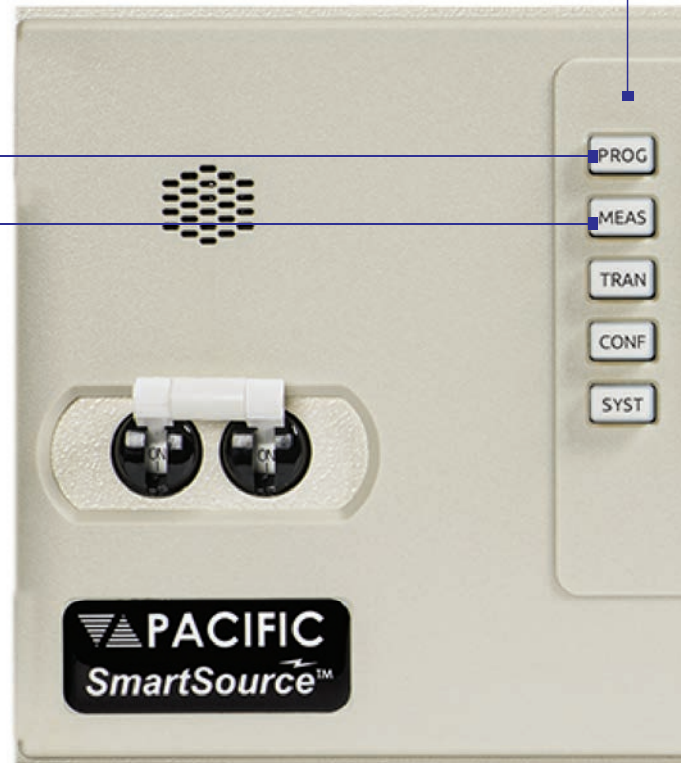

Automated Test Equipment Power for Defense Applications

Growing demand for power to support increasingly complex avionics, radar and weapons systems means more power is needed in less available space. The new LSX Series addresses this need by offering unmatched AC power quality output.

With extensive control over voltage, current, frequency, phase angles and transients, the LSX series is capable of handling complex Test Program Sets (TPS's) with minimal programming effort. Available in a range of power levels and output phase configuration to meet any AC test requirement up to 6000 VA.



Simple, Intuitive Operation

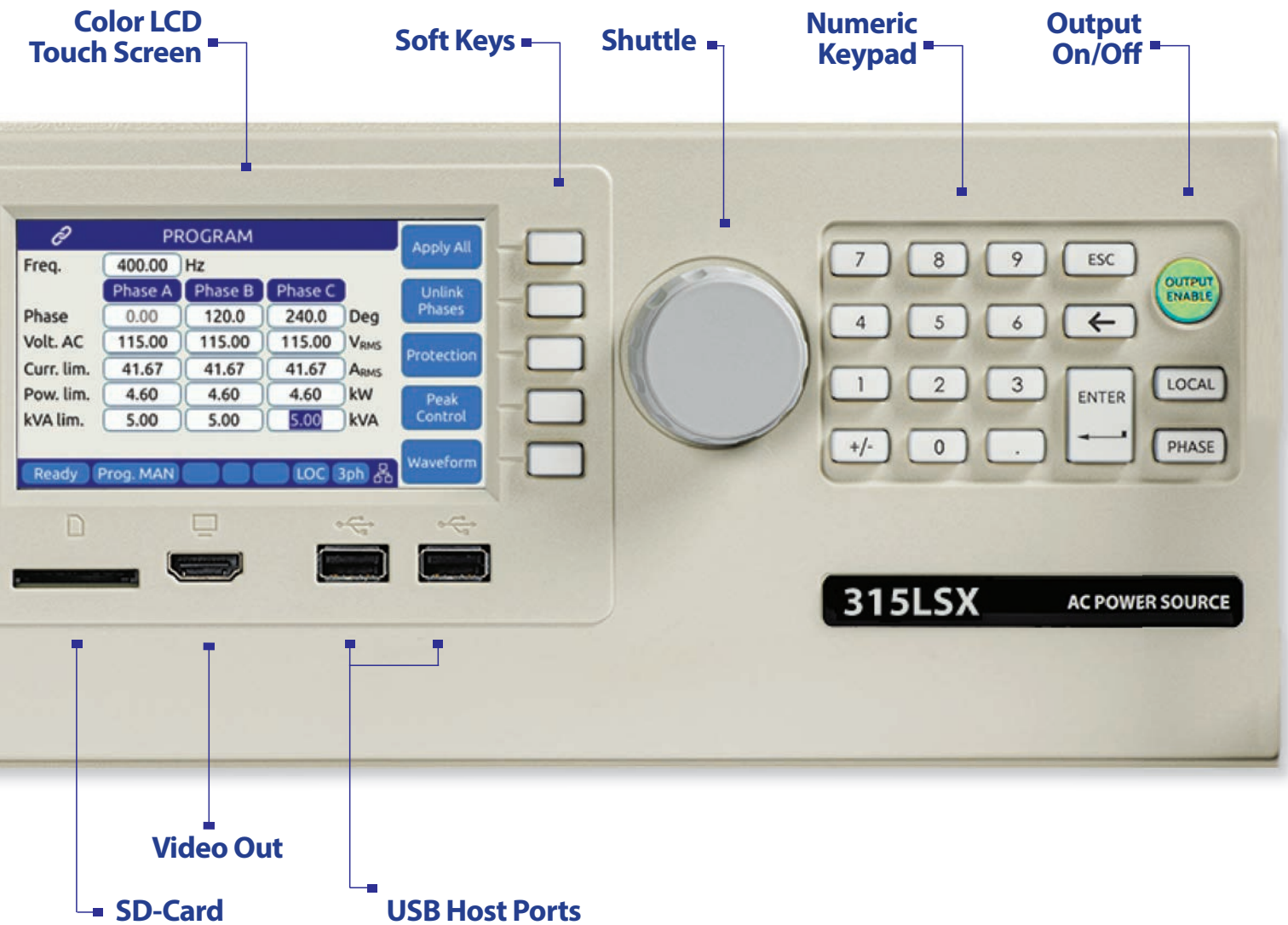

Commercial Avionics Power Test

The low noise and low distortion analog power conversion technology used in the LSX Series Power Source results in unmatched voltage quality and high peak current capability. A frequency range of 15Hz to 1200Hz supports both 400Hz fixed frequency as well as 360Hz to 800Hz wild frequency development and test with exceptional harmonics support.

For compliance testing to electrical avionics test standards like RTCA/DO160 Section 16 and Mil-Std 704, Windows 10 test software test sequences are available as an option.



Selecting the best Topology for Your Application

PWM AC Power Sources offer very good density, high efficiency, and perform well into low power factor loads. They use a combination of both linear and non-linear methods to achieve high efficiency conversion in lighter and smaller packages.

A trade-off is the method's lesser ability to provide high crest factor current and very low output distortion. The graphic below demonstrates the characteristics of PWM technology.

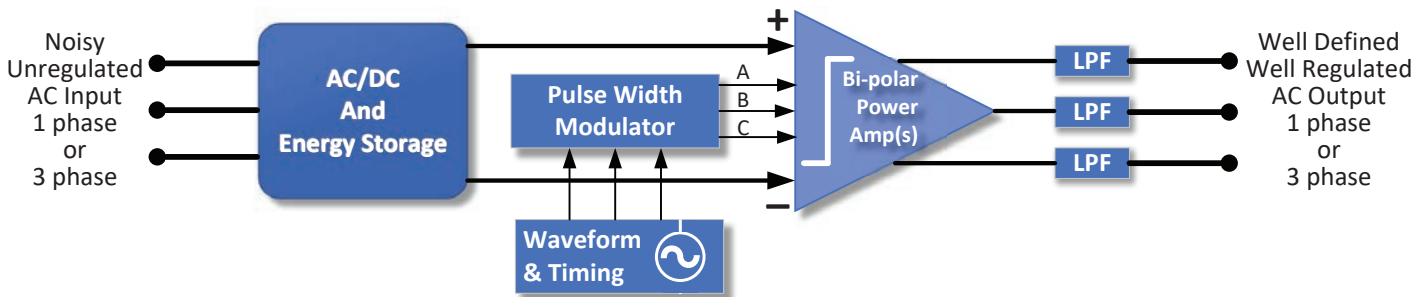

BENEFITS

- Moderately low output distortion
- Full current into very low power factor reactive loads
- Lower weight due to higher amplification efficiencies
- Smaller size compared to Linear AC Sources

FEATURE/CAPABILITY

SWITCH MODE TECH

FEATURE/CAPABILITY	SWITCH MODE TECH
Highest amplifier efficiency	✓
Lowest operating temperature	✓
Lowest weight	✓
Smallest size	✓
Lowest cost	✓
Low-power factor handling	✓

Output Phase Modes

Three phase LSX Models can be configured to operate in one of three available phase modes or FORMs:

Single Phase

Enables Single phase output with the load connected between the 1 Phase and Neutral output terminals. Voltages are programmed phase to neutral.

Split/Single Phase

Enables high range Split/Single phase output. Load is connected either between the Phase A and Phase B output terminals (full voltage) or Phase and Neutral (half voltage). Voltages are programmed phase to phase.

Three Phase

Enables Three phase output with the load connect between the A, B, C, and Neutral terminals. Loads may be connected either line to line or line to neutral. Voltages are programmed phase to neutral.

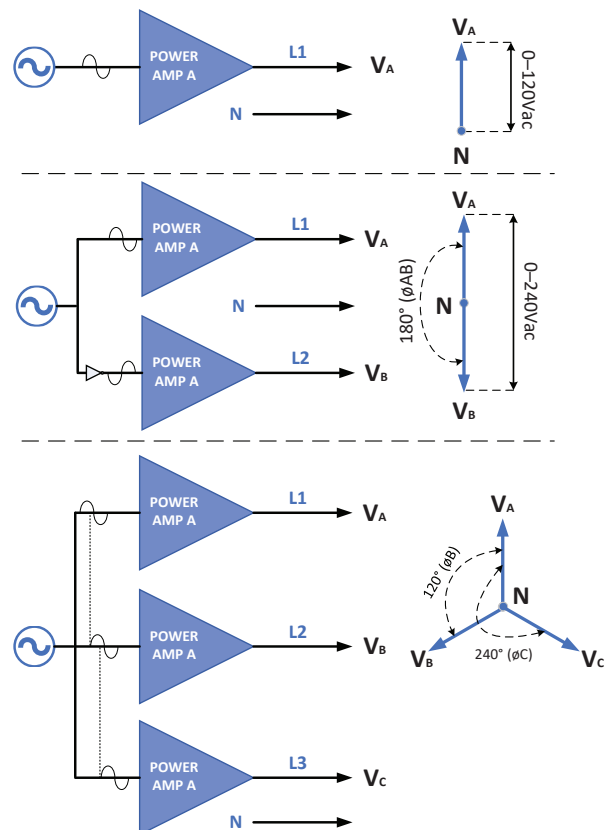

Wide Selection of Voltage Ranges

All LSX Series models support direct coupled output voltages up to 135V_{LN} or 270V_{LL} on single phase models or 135V_{LN}/234V_{LL} on three phase models.

For higher voltage output applications on three phase models, the transformer option (T-Option) offers three transformer coupled output ranges at ratios of 1:1.5, 1:2.0 or 1:2.5 for a maximum output voltage of 600V_{LL} in split phase or or 585V_{LL} in three phase mode.

Switching between direct coupled output voltage range and transformer coupled voltage range is done automatically so there is no need to disconnect and re-connect your EUT.

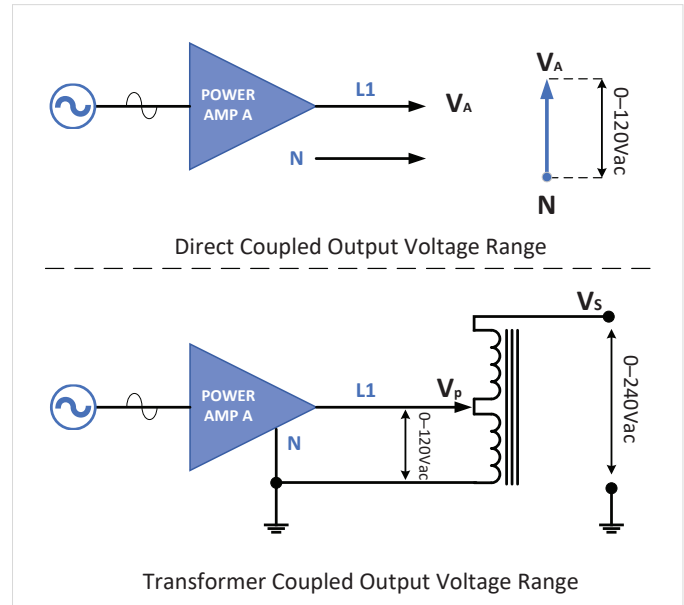

Powerful yet Easy to Use

Although LSX Series sources offer a wide range of operating modes and features, they are easy to operate through a large full color LCD display and soft key driven menus.

Top level menus are always available directly by pressing any of the five menu keys on the left of the display. Entering setup data is accomplished using the numeric keypad or the shuttle. Operating status is shown on screen using various colors to distinguish between setting, measurements and operator warnings, or error messages.

The built-in web server provides access to a large computer touch monitor based user interface with complete control over all LSX Functions and features without the need for any special software. The web browser based program and measurement screen is shown to the right.

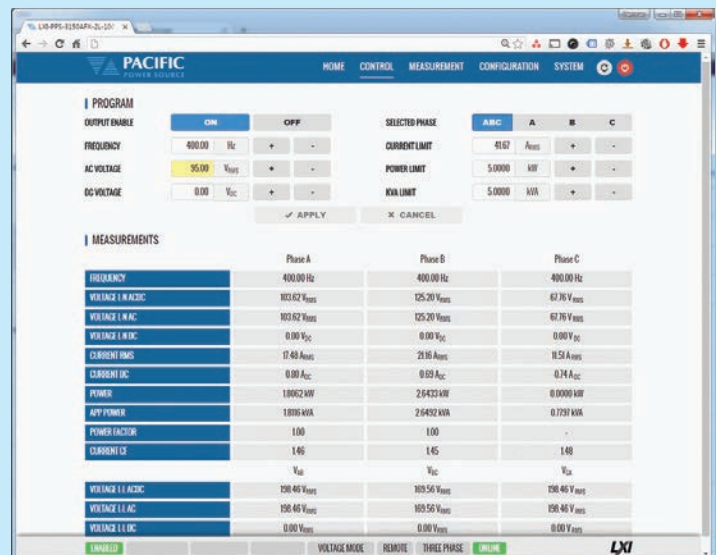

Touch Screen and WiFi Connection

The standard external HDMI™ Monitor interface supports the use of an external flat panel touch monitor for display and control of the power source. This allows measurements to be monitored from across the lab or factory floor as needed.

Alternatively, a tablet or smart phone can be used to operate the power source using the built-in LXI browser interface. Of course, extensive safety protocols are in place to prevent unauthorized access via WiFi or LAN connections.



The terms HDMI, HDMI High-Definition Multimedia Interface, and the HDMI logo are trademarks or registered trademarks of HDMI Licensing Administrator, Inc.

Transient Programming for AC Power Test Applications

Voltage, Waveform and Frequency output transients are easily created from the front panel using an intuitive spreadsheet style data entry method. Data may be entered for a specific phase or for all three phases at the same time.

The LSX Series supports LIST, PULSE and STEP Mode Transient Types. The user can select the most appropriate type from the front panel or the web server interface. The image below illustrates the three modes graphically. Transients can be stored in non-volatile memory and easily edited as needed on screen.

If preferred, transient programming and execution can be also be accomplished using the available Windows control software or web browser interface.

TRANSIENT VIEW				
#	Freq	Volt AC	Volt DC	Dwell
1	400.00	115.00	0.00	100.0
2	400.00	100.00	0.00	10.0
3	400.00	115.00	0.00	100.0
4	400.00	100.00	0.00	10.0
5	400.00	115.00	0.00	100.0
6	400.00	100.00	0.00	10.0
7	400.00	115.00	0.00	100.0
8	400.00	100.00	0.00	10.0

Ready Prog. MAN LOC 3ph

Run Step Step Mode Edit Mode Run Screen

Transient Executing in View Mode

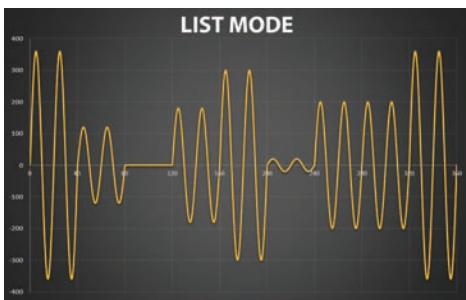

TRANSIENT LIST MODE

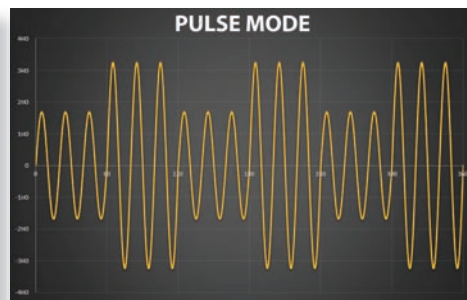

TRANSIENT PULSE MODE

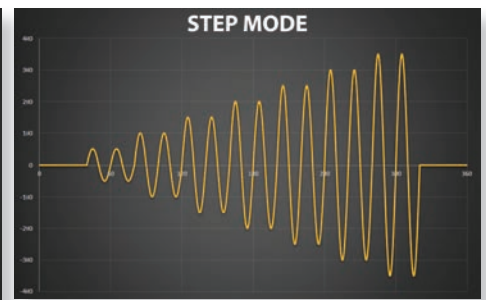

TRANSIENT STEP MODE

The LSX Series' rich feature set supports a wide variety of AC power test applications. With full control over voltage, current, frequency, power, slew rates and phase angles, no test requirement is too challenging for the LSX to handle. This includes AC power compliance testing, transformer testing, appliance testing, DC charger testing, UPS testing and more.

The scope images shown here capture several examples of AC power test waveforms generated by an LSX.



Three Phase Unbalance Voltage Test Captured

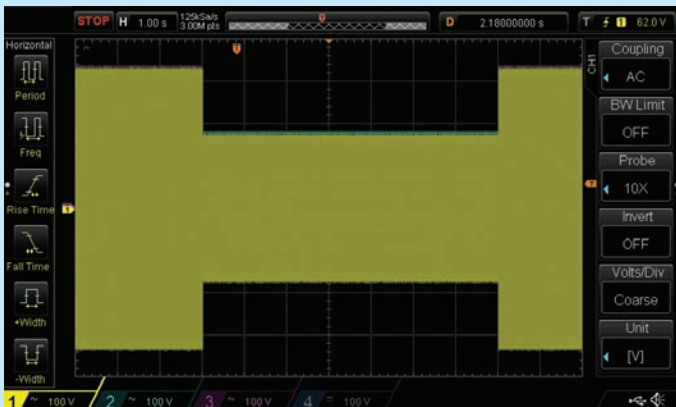

Three Phase Voltage Drop Test Captured

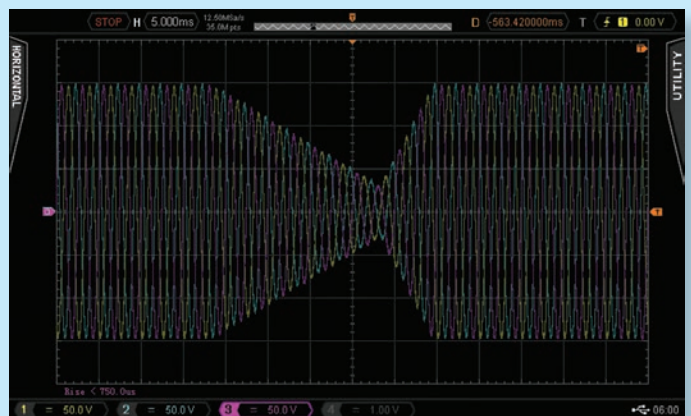

AC Transient Output Captured on Digital Scope

200 Selectable Arbitrary Waveforms

In addition to sine wave, the LSX Series offers multiple selectable AC waveforms such as clipped sine wave at various distortion levels, square, triangle and stepped squares. The operator can create arbitrary waveforms using Pacific Power's PPSC Studio Windows software or using a web browser and download these to the power source. A graphical representation (preview) of each waveform is shown on screen and a waveform name alias can be assigned to each so the operator can be sure the correct waveform is applied to the unit under test.

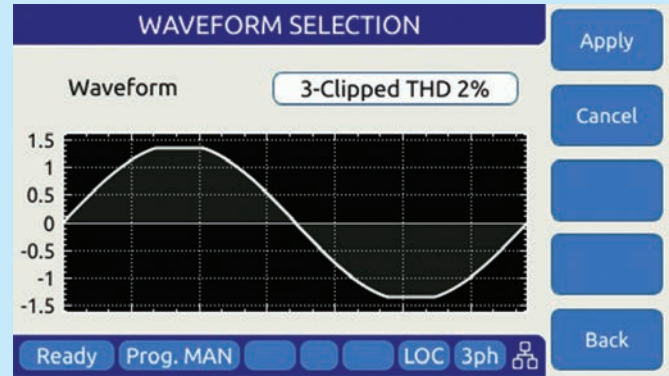

Clipped Sine Waveform Selection - Vthd = 2%

Capture Voltage & Current Waveforms

Built-in digital scope function captures voltage and current time domain signals, perfectly synchronized to the output frequency. Voltage and current displayed with accurate phase relationship. Display output waveforms on front panel or in Web browser.

The browser user interface supports more advanced digital scope functionality by utilizing a PC or tablet's larger screen area allowing multiple scope channels and periods of voltage, current and power waveforms to be captured and displayed.

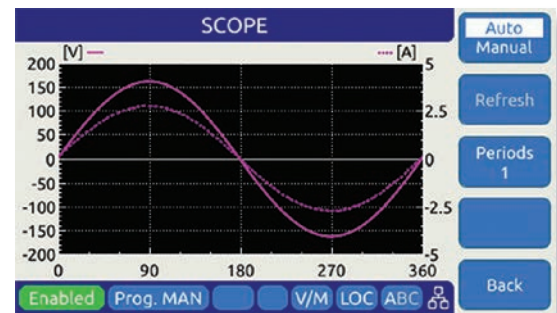

Harmonics Measurements

Eliminate the need for an external power analyzer by measuring voltage and current harmonics. Harmonics information is displayed in either bar charts or detailed table format for easy viewing and analysis.

Data is displayed for individual phase or all three phase simultaneously.

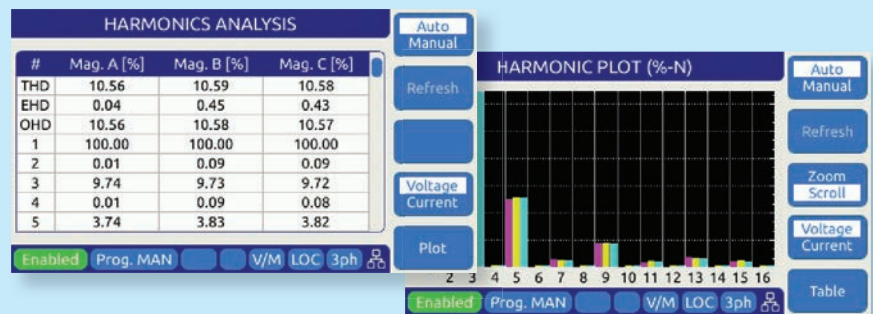

Auxiliary I/O Functions

To support integrated test system design and interaction with the load or other equipment, the LSX Series offers a range of analog and digital I/O functions.

User Programmable I/O. Assign command macros or programming parameters to analog or digital I/O pins as needed. This provides a unique level of customization for putting together sophisticated test stations.



Single Phase Models

Direct Coupled Output Units (15 Hz - 1200 Hz)

MODEL	Rated Power (VA) ¹	Output Form ²	Output Voltage Max ³ (I-n/I-l)	Output Current ⁴ (A _{rms})	Input Power ⁵	Unit Height (in.-U)	Unit Weight (lbs/kg)
115LSX	1500	1	0-132	16	1Ø	5.25-3U	65/29.5
120LSX	2000	1/2	0-150/300	20/14	1Ø	5.25-3U	75/34
140LSX	4000	1/2	0-135/270	32/16	3Ø	8.75-5U	120/54.5
160LSX	6000	1/2	0-132/264	48/16	3Ø	8.75-5U	145/66

Direct / Transformer Coupled Selectable Output Units (45 Hz - 1200 Hz)

MODEL	Rated Power (VA) ¹	Output Form ²	Output Voltage Max ³ (I-n/I-l)				Output Current ⁴ (A _{rms})				Input Power ⁵	Unit Height (in.-U) Weight (lbs/kg)	Transformer Height (in.-U) Weight (lbs/kg)
			Direct	Transformer			Direct	Transformer					
				Ratio 1.5:1	Ratio 2.0:1	Ratio 2.5:1		Ratio 1.5:1	Ratio 2.0:1	Ratio 2.5:1			
115LSXT	1500	1	0-132	0-198	0-264	0-330	16	10.7	8	6.4	1Ø	5.25-3U 80/36.4	Integrated
140LSXT	4000	1/2	0-135/270	0-202/404	0-270/540	0-338/600	32/16	21.3/10.7	16/8	12.8/6.4	3Ø	8.75-5U 120/54.5	5.25-3U 125/56.8
160LSXT	6000	1/2	0-132/264	0-198/396	0-264/528	0-330/600	48/16	32/10.6	24/8	19.2/6.4	3Ø	8.75-5U 145/66	5.25-3U 125/56.8

- Rated output power is based on a combination of output voltage, current and load power factor. Values stated represent the rated capabilities of a given model. Consult factory for assistance in determining specific unit capabilities as they might apply to your application.
- All single phase output units (Model 115 ASX excepted) are operable with dual voltage ranges as listed. Output voltage ranges and 1Ø/2Ø output form are selected by front panel or bus commands.
- Output voltage ranges listed are for standard units. VMAX is output voltage with nominal input and full rated load applied. Other voltage ranges are available with the output magnetics options below.
- Available current will vary with output voltage and power factor.
- Input power frequency is 47-63 Hz. Single phase input: 100, 110, 120, 208, 220, 230 and 240 VAC +10%. Three phase input: 208, 220, 240, 380, 400 and 416 VAC +10%.
- Single phase and 400 Hz input options may be available. Consult Factory.

LSXM Version Reduced Feature Set Summary

FEATURES	LSX	LSXM
Output Waveforms	See Page 10	Sinewave only
Phase Angles phase B, C	Programmable	Fixed: 120°,240° or 240°,120°
Transient Programming	yes	no
Programmable V,F slew rate	yes	yes
Programmable Settings	yes	yes
Measurements (scalar)	yes	yes
Harmonic Measurements	yes	no
Waveform Capture	yes	no
Programmable output Impedance (Prog-Z)	yes	no
Digital control interfaces	yes	yes
Embedded Web Server	yes	yes



115LSX Model - 1500VA - 3U (5.25")



120LSX Model - 2000VA - 3U (5.25")



140LSX Model - 4000VA - 5U (8.75")

Three Phase Models

Direct Coupled Output Units (15 Hz - 1200 Hz)

MODEL	Rated Power (VA) ¹	Output Form ²	Output Voltage Max ³ (I-n/I-l)	Output Current ⁴ (A _{rms})	Input Power ⁵	Unit Height (in.-U)	Unit Weight (lbs/kg)
315LSX	1500	1/2 3	0-132/264 0-132/228	12/6 4/Ø	1Ø	5.25-3U	75/34
320LSX	2000	1/2 3	0-150/300 0-150/260	20/12 7/Ø	1Ø	5.25-3U	85/38.5
345LSX	4500	1/2 3	0-135/270 0-135/234	36/12 12/Ø	3Ø	8.75-5U	145/66
360LSX	6000	1/2 3	0-132/264 0-132/228	48/16 16/Ø	3Ø	8.75-5U	145/66

Direct / Transformer Coupled Selectable Output Units (45 Hz - 1200 Hz)

MODEL	Rated Power (VA) ¹	Output Form ²	Output Voltage Max ³ (I-n/I-l)						Output Current ⁴ (A _{rms})						Input Power ⁵	Unit Height (in.-U) Weight (lbs/kg)	Transformer Height (in.-U) Weight (lbs/kg)
			Transformer			Transformer			Transformer			Transformer					
			Direct	Ratio 1.5:1	Ratio 2.0:1	Ratio 2.5:1	Direct	Ratio 1.5:1	Ratio 2.0:1	Ratio 2.5:1	Direct	Ratio 1.5:1	Ratio 2.0:1	Ratio 2.5:1			
345LSXT	4500	1/2 3	0-135/270 0-135/234	0-202/404 0-202/350	0-270/540 0-270/468	0-338/600 0-338/585	36/12 12/Ø	24/8 8/Ø	18/6 6/Ø	14.4/4.8 4.8/Ø	3Ø	8.75-5U 145/66	5.25-3U 125/56.8				
360LSXT	6000	1/2 3	0-132/264 0-132/228	0-198/396 0-198/343	0-264/528 0-264/457	0-330/600 0-330/572	48/16 16/Ø	32/10.7 10.7/Ø	24/8 8/Ø	19.2/6.4 6.4/Ø	3Ø	8.75-5U 145/66	5.25-3U 125/56.8				

- Rated output power is based on a combination of output voltage, current and load power factor. Values stated represent the rated capabilities of a given model. Consult factory for assistance in determining specific unit capabilities as they might apply to your application.
- All three phase units are operable as single phase with dual voltage range capability or as three phase. Output voltage ranges and 1Ø/3Ø output form are selected by front panel or bus commands.
- Output voltage ranges listed are for standard units. VMAX is output voltage with nominal input and full rated load applied. Other voltage ranges are available with the output magnetics options below.
- Current ratings at 125Vrms output. Current may vary with power factor.
- Input power frequency is 47-63 Hz. Single phase input: 100, 110, 120, 208, 200, 220, 230 and 240 VAC +10%. Three phase input: 208, 220, 240, 380, 400 and 416 VAC +10%. (480V input or 400 Hz frequency input available as a cost option on most ASX models.
- Single phase and 400 Hz input options may be available. Consult Factory.



315LSX Model - 1500VA - 3U (5.25")

360LSX Model - 6000VA - 5U (8.25")

360LSXT Model - 6000VA with Mag Module - 8U (14")

Technical Specifications (common to all LSX Models)

OUTPUT		SPECIFICATION	
Power			
Output	See Model Tables page 8 & 9		
Voltage			
Mode	AC		
Direct Coupled Range ¹	See Model Tables page 8 & 9		
T-Option Ranges	Turns ratios: 1:1.5, 1:2.0, 1:2.5		
Programming Resolution	0.01 V		
Accuracy	±0.1% (CSC mode)		
Waveforms (200 Max.)	Sine, Square, Triangle, Clipped (THD), Arbitrary		
DC Offset	< 20 mV		
Harmonic Distortion (Vthd)	Form 1	Form 3	
3U Models 15 - 200 Hz	< ± 0.25%	< ± 0.25%	
200 - 1200 Hz ²	< f x 0.7% + 0.36%	< f x 0.7% + 0.11%	
120/320LSX 15 - 200 Hz	< ± 0.25%	< ± 0.25%	
200 - 1200 Hz ²	< f x 0.7% + 0.11%	< f x 0.7% + 0.11%	
5U Models 15 - 200 Hz	< ± 0.25%	< ± 0.25%	
200 - 1200 Hz ²	< f x 1.4% + 0.22%	< f x 1.4% + 0.03%	
Note:	Under full, resistive load conditions		
Output Noise	-66 dB		
Load Regulation	Form 1	Form 3	
3U Models 15 - 200 Hz	< ± 0.25%	< ± 0.25%	
200 - 1200 Hz ²	< f x 0.7% + 0.11%	< ± 0.5%	
120/320LSX 15 - 200 Hz	< ± 0.25%	< ± 0.25%	
200 - 1200 Hz ²	< ± 0.6%	< ± 0.5%	
5U Models 15 - 200 Hz	< ± 0.25%	< ± 0.25%	
200 - 1200 Hz ²	< f x 2.5% - 0.25%	< f x 1.5% - 0.05%	
Line Regulation	< 0.1% for 10% Line Change		
Voltage Sense	External Sense, max. voltage drop 5% F.S.		
Voltage Response Time	60 µsec typical, 10-90% load step		
Isolation			
Output Neutral to Chassis	150Vac Max.		
Output Line to Chassis	338Vac Max.		
Frequency			
Direct Coupled Range	15.00 - 1200.0 Hz		
T-Option	45.00 - 1200.0 Hz		
Programming Resolution	0.01 Hz		
Accuracy	± 0.005% / 50 ppm		
Current			
Range	See Model Tables page 8 & 9		
Programming Resolution	0.01 Arms		
Accuracy ³	± (0.5% + f (kHz) * 0.5%) F.S.		
Current Protection (CP) Modes	Constant Current (CC) or Output Trip (CV)		
Phase Angle (In 3 and 2 Phase Mode)			
Programmable Phase (B, C)	0 - 359.9°		
Resolution	0.1°		
Accuracy	±0.35° / ±0.1° Phase Reg. Mode		
Programmable Impedance (Per LSX unit)			
Phase Mode	3 Phs	2 Phs	1 Phs
Real Time: Resistance (R)	±100 Ω	±200 Ω	± 33.3 Ω
Inductance (L)	0 - 50µH	0-100µH	0 - 16.7µH
RMS: Resistance (R)	±10 Ω	±20 Ω	± 3.33 Ω
Inductance (L)	0 - 2mH	0-4mH	0 - 0.67mH

TRANSIENTS	Specification
Programming	
No. of Entries	200 Steps / 400 segments
Modes	LIST, PULSE, STEP
Parameters	Frequency, Volt AC, Volt DC, Waveform, Ramp Time, Dwell Time
Dwell Time Range	0.2 - 10000000.0 msec
Time Resolution	0.1 msec
Edit Modes	Add at end, Insert before, Delete
Execution	
Run Control	Run from step # to step # Run, Step, Restart, Stop
Execution Modes	Normal, Debug
Program Storage	
Non-volatile	100 Programs + Transients

MEASUREMENTS	SPECIFICATION
AC Voltage (Vrms)	
Range	0 - 340 VLN / 0-600 VLL
Resolution	0.01 V
Accuracy	± 0.1% F.S.
Frequency (Hz)	
Fundamental Range	15 - 1200 Hz
Resolution	0.01 Hz
Accuracy	± 0.1% Rdg
AC Current (Arms)	
Range	See Model Tables page 8 & 9
Resolution	0.01 Arms
Accuracy	± (0.5% + f (kHz) * 0.5%) F.S.
Current Crest Factor	
Range	1.00 - 5.00
Resolution	0.01
Accuracy ¹	± 2.0% F.S.
AC or DC Power (W)	
Range	See Model Tables page 8 & 9
Resolution	1 W front panel / 0.1 W remote
Accuracy	± 0.75 % F.S.
Apparent Power (VA)	
Range	See Model Tables page 8 & 9
Resolution	1 VA front panel / 0.1 VA remote
Accuracy ¹	± 0.75 % F.S.
Power Factor	
Range	0.00 - 1.00
Resolution	0.01

Note 1: Specification valid above 40Hz

WAVEFORM CAPTURE	SPECIFICATION
Parameters	V _{LN-A} , V _{LN-B} , V _{LN-C} , V _{LL AB} , V _{LL AC} , V _{LL BC} , I _A , I _B , I _C
Max. Sample Rate	500 ksps
Samples/cycle	1024 (512 in UPC Compatibility mode)
Record Length	8 MSamples
Bandwidth	100 kHz @ 500 ksps

Note 1: V_{LL} applies to three phase LSX Models in three phase mode

Note 2: Frequency "f" is in kHz

Note 3: Specification valid above 40Hz



Technical Specifications (continued)

HARMONICS MEAS.	SPECIFICATION
Parameters	VLN-A, VLN-B, VLN-C, VLL AB, VLL AC, VLL BC, IA, IB, IC
Harmonics Range	H2 ~ H50
Accuracy – Amplitude	± 1.0 % of RMS Reading
Phase Angle Range	0 ~ 359.9
Accuracy - Phase Angle	< 8 µsec
Bandwidth	100 kHz @ 500 ksps
Display Modes	Table format, Graph format

AC INPUT	SPECIFICATION
Mains Voltage Form	4 Wire, L1, L2, L3 and PE
Frequency	47 - 63 Hz
Single Phase AC Input Selections	
Input Voltages	100, 110, 120, 200, 208, 220, 230 or 240 Vac
Phase Current	Model specific
Three Phase AC Input Selections	
Input Voltages	208, 220, 240, 380, 400, 416 or 480 ¹ Vac
Phase Current	Model specific

ENVIRONMENTAL	SPECIFICATION
Cooling	Variable speed fan cooled, front and/or side air intake, rear exhaust. 115/120/315/320 Models: 200 CFM 140/160/345/360 Models: 300 CFM
Audible Noise	65 dBA Max. @ 1 meter
Temperature	
Operating	0 to 55 °C / 32 to 131 °F
Storage	-10 to 70 °C / 14 to 158 °F
Humidity	< 0 - 95 %, non-condensing
Altitude	Operating: 1,981 m / 6500 feet Storage: 12,192 m / 40,000 feet

SYSTEM FEATURES	DESCRIPTION
DISPLAY	
Type	Full Color, Touch LCD Display
Size	4.3" Diagonal
Resolution	480 x 272 pixels
USB Ports	2 Front Panel, 1 Rear Panel, Type A
SD Card	32 GB max. Capacity
Video Output	Monitor Out, Front Panel

INTERFACES	DESCRIPTION
Remote Control	
USB	Device Type B
RS232	1200 - 921600 baud
 LAN	LXI compliant, Ethernet, RJ45, TCP/IP Protocol, Telnet Protocol Command Line
GPIB	IEEE488.1, IEEE488.2 (2003 incl., NI HS488) IEC 60488-1, IEC 60488-2 (2004) Functions: SH1, AH1, T6, L3, SR1, RL1, DC1, DT1
 WiFi	Optional USB WiFi adaptor available

ANALOG I/O	SPECIFICATION
Analog Inputs (4)	
Modes	Amplifier, Amplitude Modulation, Int. + Ext. Input Summing
AI1, AI2, AI3	Programmable setting phs A, B, C
AI4	Frequency
Range	0 to ±10 Vdc for 0 - F.S.
Accuracy	± 0.1% F.S.
Impedance	10 kOhm
Analog Outputs (4)	
AO1, AO2, AO3	Voltage Meas. phs A, B, C
AO4	Power Measurement Total
Range	0 - 5Vdc for 0 - F.S.
Accuracy	± 0.1% F.S. into > 5 kOhm load
Impedance	5 kOhm
Connector Type	DB25, Rear Panel

DIGITAL I/O	SPECIFICATION
Digital Inputs (6)	
Fixed (3)	Remote Inhibit, Transient Trigger, Phase Sync
User Programmable (3)	DI1, DI2, DI3
Input Levels	Low < 0.4V, High > 2.0V
Digital Outputs (6)	
Open Collector, Fixed (2)	Relay Control FORM, Relay Control T Option
TTL, Fixed (2)	Output Relay/Transient /Function Strobe Phase Sync
User Programmable (2)	DO1, DO2
Output Levels	Low < 0.4V, High > 4.6V
Connector Type	DB25, Rear Panel

MECHANICAL	SPECIFICATION
Dimensions	
Width	19" / 482 mm
Height	See Model Tables page 8 & 9
Depth	3U Models: 23.0" / 584 mm 5U Models: 23.12" / 587 mm <i>(Includes rear connectors, excludes rack handles)</i>
Weight	
Net	See Model Tables page 8 & 9

PROTECTION	SPECIFICATION
Types	AC or DC Current, True Power, Apparent Power, Over Voltage, Over Temperature

Note 1: 480Vac Input is an available option on some models. Consult factory.

Ordering Information

Standard Models

Single Phase Models (T = Option)

- 115LSX(T)
- 120LSX
- 140LSX(T)
- 160LSX(T)
- 115LSXM(T)
- 120LSXM
- 140LSXM(T)
- 160LSXM(T)

Three Phase Models (T = Option)

- 315LSX¹
- 320LSX¹
- 345LSX(T)
- 360LSX(T)
- 315LSXM
- 320LSXM
- 345LSXM(T)
- 360LSXM(T)

AC Input Voltages (V_{IN})

- Must be specified on order, see pages 8 & 9

Options

- C Interharmonics Generator Option
- E Export version, "E" postfix

Order Example

- 360LSX
- AC Power Source, 6000VA, 3-Phase, No T-Option, USB, RS232, LAN, GPIB & AUX I/O
 - Specify Factory set AC Input Voltage

Typical Delivery Items

- AC Power Source
- English Manuals in PDF Format
- Certificate of Compliance

Model Number Configurator¹

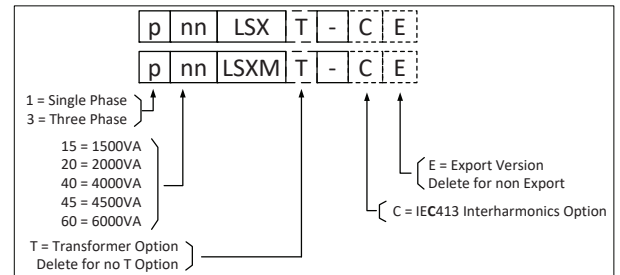

Note 1: For External Transformer option on 315LSX & 320LSX models, refer to option M99222

Software Options

Windows 10 Software - 64 Bit

- PPSC Studio Control Software
- PPSC Test Manager

Test Sequences - Avionics²

- ABD0100.1.8 - Airbus A380, AC Power Groups
- ABD0100.1.8.1 - Airbus A350, AC Power Groups
- AMD24C - Airbus A400M, AC Power Groups
- Boeing 787B3-0147 - B787, AC Power Groups
- MIL-STD704 - US DoD, AC Power Groups
- RTCA-DO160 Section 16, AC Power Groups

Test Sequences - Other²

- IEC Test Suite - Includes IEC61000-4-11p, IEC61000-4-14, IEC61000-4-27p, IEC61000-4-28 and IEC61000-4-34p
- MIL-STD 1399-300B - US DoD, Ship-board Power, AC Power Groups

Service and Support

Pacific Power Source's customer support is second to none. Our Customer Support Program provides the training, repair, calibration, and technical support services that our customers value. In addition to receiving the right test equipment, our customers can also count on excellent support before, during and after the sale. With company owned support and service centers around the world, support is never far away.

Complete calibration and repair services are offered at our US, European and Chinese manufacturing facilities (see contact info below). Calibrations are to original factory specifications and are traceable to NIST (National Institute of Standards and Technology).

Proudly Represented by:

4TECT

OOO «4TECT»
 Телефон: +7 (499) 685-4444
 info@4test.ru
 www.4test.ru